

10,000 PSI (690 BAR) 5-WAY TRUNNION VALVES

Model No. 5K103

*MAWP: 10,000 PSI (690 bar)
 Port: 0.187" (4.7 mm)
 Cv: 0.56

Materials of Construction:

- 316 cold-worked stainless steel body and side adapters
- 17-4PH stem
- PEEK ball seals
- Viton O-rings
- PTFE back-ups

Ordering information and options on page BV-2

Repair Kit P/N RK-5K103 contains stem, trunnion, trunnion seals and seal retainers, o-rings, backups, spring washers, and bearing washers

Mounting:

Panel: 1.06" (26.9 mm) dia
 0.25" (6.4 mm) max thickness
 Top: 1/4"-20 UNC

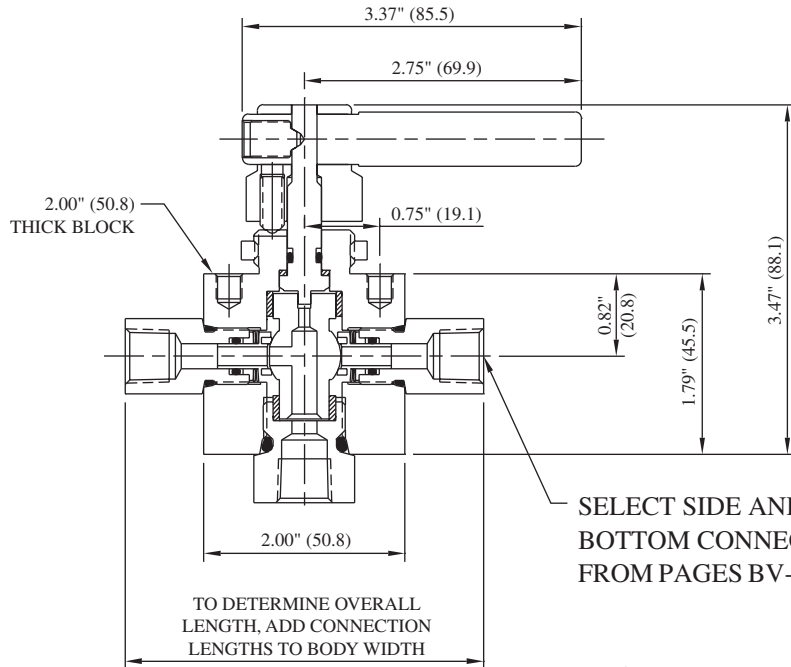

SELECT SIDE AND BOTTOM CONNECTIONS FROM PAGES BV-40 & BV-41

For replacement connections, use prefix number **3-** and suffix number. Ex: 3-20

FEMALE PIPE

Connection	For Side Connections				For Bottom Connection				MAWP*
	Suffix	Hex	Length	Port	Suffix	Hex	Length	Port	
1/8" FNPT	19	0.75" (19.1)	0.60" (15.2)	0.250" (6.4)	19B	1.00" (25.4)	0.63" (16.0)	0.250" (6.4)	15,000 PSI 1030 bar
1/4" FNPT	20	0.75" (19.1)	0.60" (15.2)	0.250" (6.4)	20B	1.00" (25.4)	0.55" (14.0)	0.250" (6.4)	15,000 PSI 1030 bar
3/8" FNPT	21	1.00" (25.4)	1.01" (25.7)	0.250" (6.4)	21B	1.00" (25.4)	1.01" (25.7)	0.250" (6.4)	15,000 PSI 1030 bar
1/2" FNPT	22	1.00" (25.4)	1.01" (25.7)	0.250" (6.4)	22B	1.00" (25.4)	1.16" (29.5)	0.250" (6.4)	15,000 PSI 1030 bar

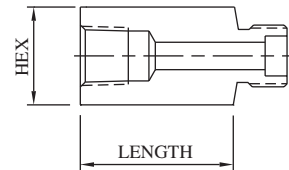

MALE PIPE

Connection	For Side Connections				For Bottom Connection				MAWP*
	Suffix	Hex	Length	Port	Suffix	Hex	Length	Port	
1/8" MNPT	4	0.75" (19.1)	1.01" (25.7)	0.125" (3.2)	4B	1.00" (25.4)	0.93" (23.6)	0.125" (3.2)	15,000 PSI 1030 bar
1/4" MNPT	5	0.75" (19.1)	1.01" (25.7)	0.250" (6.4)	5B	1.00" (25.4)	1.05" (26.7)	0.250" (6.4)	15,000 PSI 1030 bar
3/8" MNPT	6	0.75" (19.1)	1.01" (25.7)	0.250" (6.4)	6B	1.00" (25.4)	1.01" (25.7)	0.250" (6.4)	15,000 PSI 1030 bar
1/2" MNPT	7	1.00" (25.4)	1.26" (32.0)	0.250" (6.4)	7B	1.00" (25.4)	1.29" (32.8)	0.250" (6.4)	15,000 PSI 1030 bar

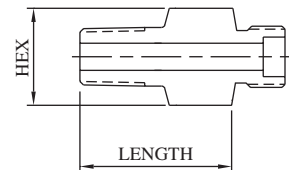

***CAUTION:** The maximum allowable working pressure (MAWP) of the valve shall not exceed the MAWP of the valve series or the selected connection, whichever is less.

All dimensions are for reference only and are subject to change.
 Dimensions in parentheses are millimeters (mm).



10,000 PSI (690 BAR) 5-WAY TRUNNION VALVES

Model No. **5K103**

FEMALE SINGLE-FERRULE TUBE

Connection	For Side Connections				For Bottom Connection				MAWP*
	Suffix	Hex	Length	Port	Suffix	Hex	Length	Port	
1/8" L/P	12	0.75" (19.1)	0.78" (19.8)	0.093" (2.4)	12B	1.00" (25.4)	0.55" (14.0)	0.093" (2.4)	15,000 PSI 1030 bar
1/4" SL/P	13	0.75" (19.1)	1.03" (26.2)	0.125" (3.2)	13B	1.00" (25.4)	0.83" (21.0)	0.125" (3.2)	11,500 PSI 790 bar
3/8" SL/P	14	0.75" (19.1)	1.03" (26.2)	0.250" (6.4)	14B	1.00" (25.4)	1.01" (25.7)	0.250" (6.4)	7,500 PSI 520 bar
1/2" L/P	15	1.00" (25.4)	1.03" (26.2)	0.250" (6.4)	15B	1.00" (25.4)	1.01" (25.7)	0.250" (6.4)	5,500 PSI 380 bar

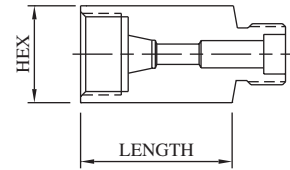

FEMALE M/P CONED AND THREADED TUBE

Connection	For Side Connections				For Bottom Connection				MAWP*
	Suffix	Hex	Length	Port	Suffix	Hex	Length	Port	
1/4" M/P	16	0.75" (19.1)	0.74" (18.8)	0.109" (2.8)	16B	1.00" (25.4)	0.76" (19.3)	0.109" (2.8)	20,000 PSI 1380 bar
3/8" M/P	17	0.75" (19.1)	1.01" (25.7)	0.203" (5.2)	17B	1.00" (25.4)	0.83" (21.0)	0.203" (5.2)	20,000 PSI 1380 bar
9/16" M/P	18	1.00" (25.4)	1.26" (32.0)	0.250" (6.4)	18B	1.00" (25.4)	1.01" (25.7)	0.312" (7.9)	20,000 PSI 1380 bar

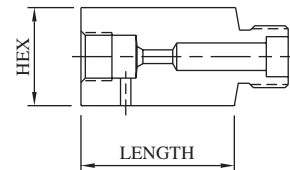

MALE M/P CONED AND THREADED TUBE

Connection	For Side Connections				For Bottom Connection				MAWP*
	Suffix	Hex	Length	Port	Suffix	Hex	Length	Port	
1/4" M/P	8	0.75" (19.1)	1.88" (47.8)	0.109" (2.8)	8B	1.00" (25.4)	1.88" (47.8)	0.109" (2.8)	20,000 PSI 1380 bar
3/8" M/P	10	0.75" (19.1)	2.00" (50.8)	0.203" (5.2)	10B	1.00" (25.4)	2.00" (50.8)	0.203" (5.2)	20,000 PSI 1380 bar
9/16" M/P	11	1.00" (25.4)	2.31" (58.7)	0.250" (6.4)	11B	1.12" (28.4)	2.95" (74.9)	0.312" (7.9)	20,000 PSI 1380 bar

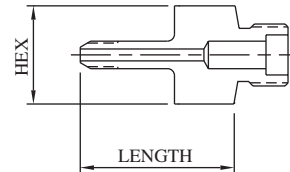

FEMALE H/P CONED AND THREADED TUBE

Connection	For Side Connections				For Bottom Connection				MAWP*
	Suffix	Hex	Length	Port	Suffix	Hex	Length	Port	
1/4" H/P	23	0.75" (19.1)	1.01" (25.7)	0.093" (2.4)	23B	1.00" (25.4)	0.89" (22.6)	0.093" (2.4)	20,000 PSI 1380 bar
3/8" H/P	24	1.00" (25.4)	1.17" (29.7)	0.125" (3.2)	24B	1.00" (25.4)	0.99" (25.1)	0.125" (3.2)	20,000 PSI 1380 bar
9/16" H/P	25	1.37" (34.8)	1.25" (31.8)	0.187" (4.7)	25B	1.37" (34.8)	1.25" (31.8)	0.187" (4.7)	20,000 PSI 1380 bar

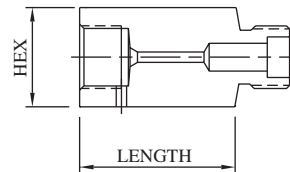

MALE H/P CONED AND THREADED TUBE

Connection	For Side Connections				For Bottom Connection				MAWP*
	Suffix	Hex	Length	Port	Suffix	Hex	Length	Port	
1/4" H/P	9	0.75" (19.1)	1.94" (49.3)	0.083" (2.1)	9B	1.00" (25.4)	2.12" (53.8)	0.083" (2.1)	20,000 PSI 1380 bar
3/8" H/P	30	0.75" (19.1)	2.25" (57.2)	0.125" (3.2)	30B	1.00" (25.4)	2.35" (59.7)	0.125" (3.2)	20,000 PSI 1380 bar
9/16" H/P	42	0.75" (19.1)	2.82" (71.6)	0.187" (4.7)	42B	1.00" (25.4)	2.88" (73.2)	0.187" (4.7)	20,000 PSI 1380 bar

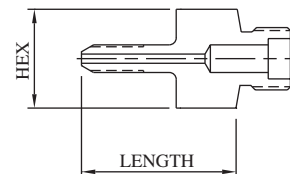

***CAUTION:** The maximum allowable working pressure (MAWP) of the valve shall not exceed the MAWP of the valve series or the selected connection, whichever is less.



All dimensions are for reference only and are subject to change.
Dimensions in parentheses are millimeters (mm).

10,000 PSI (690 BAR) 5-WAY TRUNNION VALVES

Model No. 5K106

*MAWP: 10,000 PSI (690 bar)
 Port: 0.375" (9.5 mm)
 Cv: 2.40

Materials of Construction:

- 316 cold-worked stainless steel body and side adapters
- 17-4PH stem
- PEEK ball seals
- Viton O-rings
- PTFE back-ups

Ordering information and options on page BV-2

Repair Kit P/N RK-5K106 contains stem, trunnion, trunnion seals and seal retainers, o-rings, backups, spring washers, and bearing washers

Mounting:

Panel: 1.28" (32.5 mm) dia
 0.43" (11.0 mm) max thickness
 Side: 0.28" (7.1 mm) dia

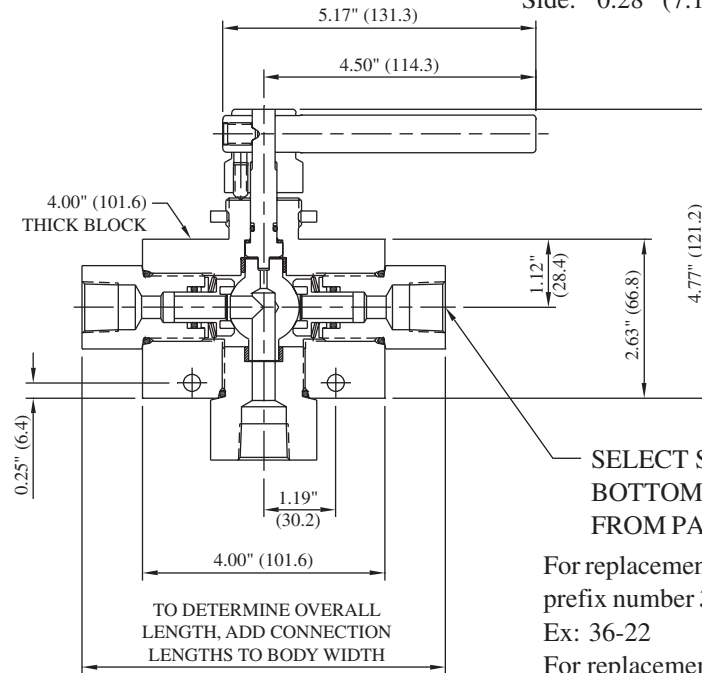

SELECT SIDE AND BOTTOM CONNECTIONS FROM PAGES BV-42 & BV-43

For replacement side connections, use prefix number **36-** and suffix number. Ex: 36-22

For replacement bottom connections, use prefix number **46-** and suffix number. Ex: 46-22B

FEMALE PIPE

Connection	For Side Connections				For Bottom Connection				MAWP*
	Suffix	Hex	Length	Port	Suffix	Hex	Length	Port	
1/8" FNPT	19	1.38" (35.1)	0.47" (11.9)	0.339" (8.6)	19B	1.75" (44.5)	0.47" (11.9)	0.339" (8.6)	15,000 PSI 1030 bar
1/4" FNPT	20	1.38" (35.1)	1.00" (25.4)	0.437" (11.1)	20B	1.75" (44.5)	0.37" (9.4)	0.375" (9.5)	15,000 PSI 1030 bar
3/8" FNPT	21	1.38" (35.1)	1.00" (25.4)	0.500" (12.7)	21B	1.75" (44.5)	1.06" (26.9)	0.375" (9.5)	15,000 PSI 1030 bar
1/2" FNPT	22	1.38" (35.1)	1.00" (25.4)	0.500" (12.7)	22B	1.75" (44.5)	1.11" (28.2)	0.375" (9.5)	15,000 PSI 1030 bar
3/4" FNPT	41	1.38" (35.1)	1.10" (27.9)	0.500" (12.7)	41B	1.75" (44.5)	1.17" (29.7)	0.375" (9.5)	10,000 PSI 690 bar
1" FNPT	45	1.75" (44.5)	1.75" (44.5)	0.500" (12.7)	45B	1.75" (44.5)	1.75" (44.5)	0.500" (12.7)	10,000 PSI 690 bar

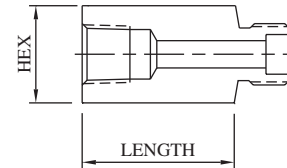

MALE PIPE

Connection	For Side Connections				For Bottom Connection				MAWP*
	Suffix	Hex	Length	Port	Suffix	Hex	Length	Port	
1/8" MNPT	4	1.38" (35.1)	1.08" (27.4)	0.187" (4.7)	4B	1.75" (44.5)	1.09" (27.7)	0.187" (4.7)	15,000 PSI 1030 bar
1/4" MNPT	5	1.38" (35.1)	1.22" (31.0)	0.250" (6.4)	5B	1.75" (44.5)	1.31" (33.3)	0.250" (6.4)	15,000 PSI 1030 bar
3/8" MNPT	6	1.38" (35.1)	1.23" (31.2)	0.375" (9.5)	6B	1.75" (44.5)	1.43" (36.3)	0.375" (9.5)	15,000 PSI 1030 bar
1/2" MNPT	7	1.38" (35.1)	1.59" (40.4)	0.375" (9.5)	7B	1.75" (44.5)	1.63" (41.4)	0.375" (9.5)	15,000 PSI 1030 bar
3/4" MNPT	55	1.38" (35.1)	1.62" (41.1)	0.500" (12.7)	55B	1.75" (44.5)	1.65" (41.9)	0.375" (9.5)	10,000 PSI 690 bar
1" MNPT	56	1.50" (38.1)	1.87" (47.5)	0.500" (12.7)	56B	1.75" (44.5)	1.90" (48.3)	0.375" (9.5)	10,000 PSI 690 bar

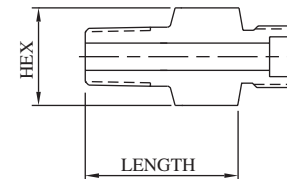

***CAUTION:** The maximum allowable working pressure (MAWP) of the valve shall not exceed the MAWP of the valve series or the selected connection, whichever is less.

All dimensions are for reference only and are subject to change.
 Dimensions in parentheses are millimeters (mm).



10,000 PSI (690 BAR) 5-WAY TRUNNION VALVES

Model No. **5K106**

FEMALE SINGLE-FERRULE TUBE

Connection	For Side Connections				For Bottom Connection				MAWP*
	Suffix	Hex	Length	Port	Suffix	Hex	Length	Port	
1/4" SL/P	13	1.38" (35.1)	0.64" (16.3)	0.187" (4.7)	13B	1.75" (44.5)	0.66" (16.8)	0.187" (4.7)	11,500 PSI 790 bar
3/8" SL/P	14	1.38" (35.1)	0.75" (19.1)	0.312" (7.9)	14B	1.75" (44.5)	0.75" (19.1)	0.312" (7.9)	7,500 PSI 520 bar
1/2" L/P	15	1.38" (35.1)	1.06" (26.9)	0.437" (11.1)	15B	1.75" (44.5)	1.06" (26.9)	0.375" (9.5)	5,500 PSI 380 bar

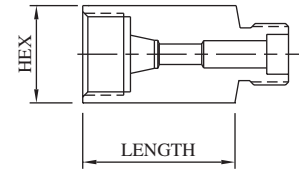

FEMALE M/P CONED AND THREADED TUBE

Connection	For Side Connections				For Bottom Connection				MAWP*
	Suffix	Hex	Length	Port	Suffix	Hex	Length	Port	
1/4" M/P	16	1.38" (35.1)	0.65" (16.5)	0.109" (2.8)	16B	1.75" (44.5)	1.11" (28.2)	0.109" (2.8)	20,000 PSI 1380 bar
3/8" M/P	17	1.38" (35.1)	1.06" (26.9)	0.203" (5.2)	17B	1.75" (44.5)	1.06" (26.9)	0.203" (5.2)	20,000 PSI 1380 bar
9/16" M/P	18	1.38" (35.1)	1.31" (33.3)	0.312" (7.9)	18B	1.75" (44.5)	1.06" (26.9)	0.312" (7.9)	20,000 PSI 1380 bar
3/4" M/P	32	1.38" (35.1)	1.52" (38.6)	0.437" (11.1)	32B	1.75" (44.5)	1.18" (30.0)	0.375" (9.5)	20,000 PSI 1380 bar
1" M/P	43	1.75" (44.5)	1.91" (48.5)	0.500" (12.7)	43B	1.75" (44.5)	1.99" (50.5)	0.375" (9.5)	20,000 PSI 1380 bar

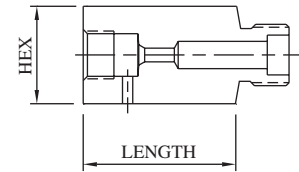

MALE M/P CONED AND THREADED TUBE

Connection	For Side Connections				For Bottom Connection				MAWP*
	Suffix	Hex	Length	Port	Suffix	Hex	Length	Port	
1/4" M/P	8	1.38" (35.1)	1.91" (48.5)	0.109" (2.8)	8B	1.75" (44.5)	1.93" (49.0)	0.109" (2.8)	20,000 PSI 1380 bar
3/8" M/P	10	1.38" (35.1)	1.87" (47.5)	0.203" (5.2)	10B	1.75" (44.5)	2.17" (55.1)	0.203" (5.2)	20,000 PSI 1380 bar
9/16" M/P	11	1.38" (35.1)	3.21" (81.5)	0.312" (7.9)	11B	1.75" (44.5)	2.18" (55.4)	0.312" (7.9)	20,000 PSI 1380 bar
3/4" M/P	37	1.38" (35.1)	3.54" (89.9)	0.437" (11.1)	37B	1.75" (44.5)	5.06" (128.5)	0.437" (11.1)	20,000 PSI 1380 bar
1" M/P	49	1.38" (35.1)	3.20" (81.3)	0.500" (12.7)	49B	1.75" (44.5)	3.25" (82.6)	0.500" (12.7)	20,000 PSI 1380 bar

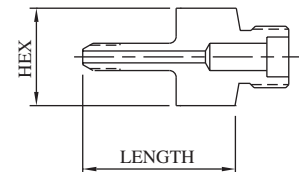

FEMALE H/P CONED AND THREADED TUBE

Connection	For Side Connections				For Bottom Connection				MAWP*
	Suffix	Hex	Length	Port	Suffix	Hex	Length	Port	
1/4" H/P	23	1.38" (35.1)	0.58" (14.7)	0.093" (2.4)	23B	1.75" (44.5)	0.60" (15.2)	0.093" (2.4)	20,000 PSI 1380 bar
3/8" H/P	24	1.38" (35.1)	0.89" (22.6)	0.125" (3.2)	24B	1.75" (44.5)	0.91" (23.1)	0.125" (3.2)	20,000 PSI 1380 bar
9/16" H/P	25	1.50" (38.1)	0.98" (24.9)	0.187" (4.7)	25B	1.75" (44.5)	1.02" (25.9)	0.187" (4.7)	20,000 PSI 1380 bar

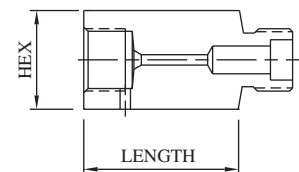

MALE H/P CONED AND THREADED TUBE

Connection	For Side Connections				For Bottom Connection				MAWP*
	Suffix	Hex	Length	Port	Suffix	Hex	Length	Port	
1/4" H/P	9	1.38" (35.1)	2.16" (54.9)	0.083" (2.1)	9B	1.75" (44.5)	2.19" (55.6)	0.083" (2.1)	20,000 PSI 1380 bar
3/8" H/P	30	1.38" (35.1)	2.40" (61.0)	0.125" (3.2)	30B	1.75" (44.5)	2.42" (61.5)	0.125" (3.2)	20,000 PSI 1380 bar
9/16" H/P	42	1.38" (35.1)	2.89" (73.4)	0.187" (4.7)	42B	1.75" (44.5)	2.92" (74.2)	0.187" (4.7)	20,000 PSI 1380 bar

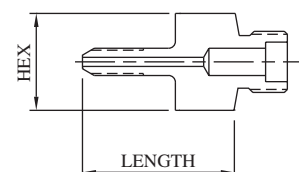

***CAUTION:** The maximum allowable working pressure (MAWP) of the valve shall not exceed the MAWP of the valve series or the selected connection, whichever is less.



All dimensions are for reference only and are subject to change.
Dimensions in parentheses are millimeters (mm).