

3000 PSI (210 BAR) 2-WAY BALL VALVES

Model No. K34

Mounting:

Panel: 0.78" (19.8 mm) dia
0.37" (9.4 mm) max thickness

*MAWP: 3,000 PSI (210 bar)
Port: 0.250" (6.4 mm)
Cv: 1.40

Materials of Construction:

- 316 cold-worked stainless steel body and side adapters
- 316 cold-worked stem
- PEEK ball seals
- Glass-filled PTFE stem packings
- Viton O-rings

Ordering information and options on page BV-2

Repair Kit P/N RK-K34 contains ball, ball seals and seal retainers, o-rings, pins, stem, stem packings, and washers

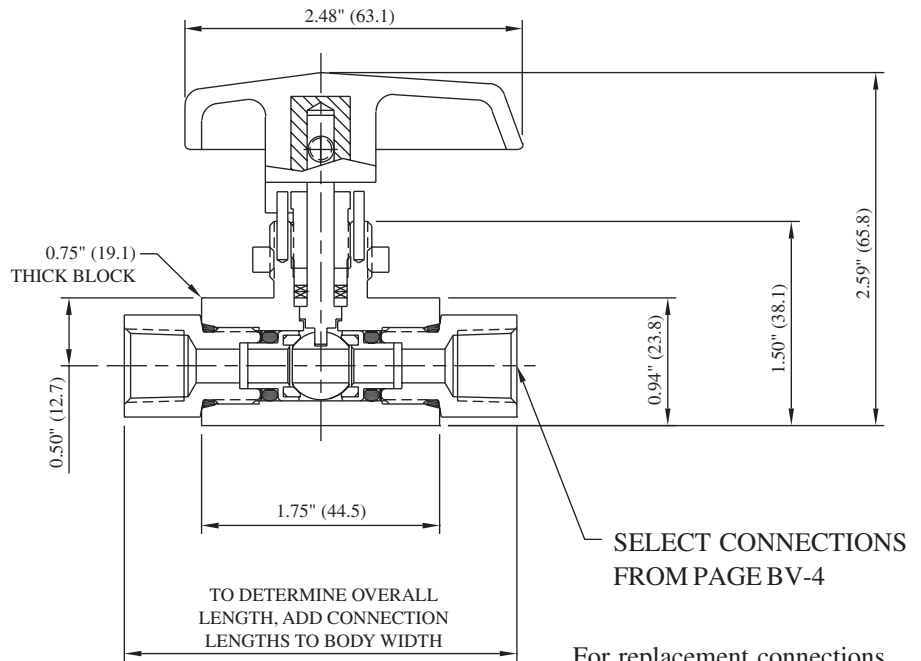

For replacement connections, use prefix number **40-** and suffix number. Ex: 40-20

FEMALE PIPE

Connection	Suffix	Hex	Length	Port	MAWP*
1/8" FNPT	19	0.75" (19.1)	0.58" (14.7)	0.250" (6.4)	15,000 PSI 1030 bar
1/4" FNPT	20	0.75" (19.1)	0.58" (14.7)	0.250" (6.4)	15,000 PSI 1030 bar
3/8" FNPT	21	1.00" (25.4)	0.75" (19.1)	0.250" (6.4)	15,000 PSI 1030 bar
1/2" FNPT	22	1.18" (30.0)	1.00" (25.4)	0.250" (6.4)	15,000 PSI 1030 bar

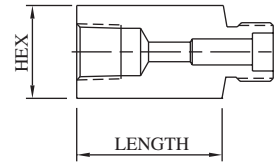

MALE PIPE

Connection	Suffix	Hex	Length	Port	MAWP*
1/8" MNPT	4	0.75" (19.1)	0.97" (24.6)	0.250" (6.4)	15,000 PSI 1030 bar
1/4" MNPT	5	0.75" (19.1)	1.19" (30.2)	0.250" (6.4)	15,000 PSI 1030 bar
3/8" MNPT	6	1.00" (25.4)	1.30" (33.0)	0.250" (6.4)	15,000 PSI 1030 bar
1/2" MNPT	7	1.00" (25.4)	1.55" (39.4)	0.250" (6.4)	15,000 PSI 1030 bar

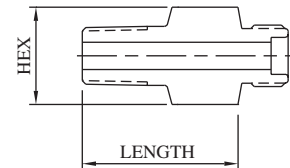

***CAUTION:** The maximum allowable working pressure (MAWP) of the valve shall not exceed the MAWP of the valve series or the selected connection, whichever is less.

All dimensions are for reference only and are subject to change.
Dimensions in parentheses are millimeters (mm).



3000 PSI (210 BAR) 2-WAY BALL VALVES

Mounting:

Side: 0.47" (11.9 mm) dia

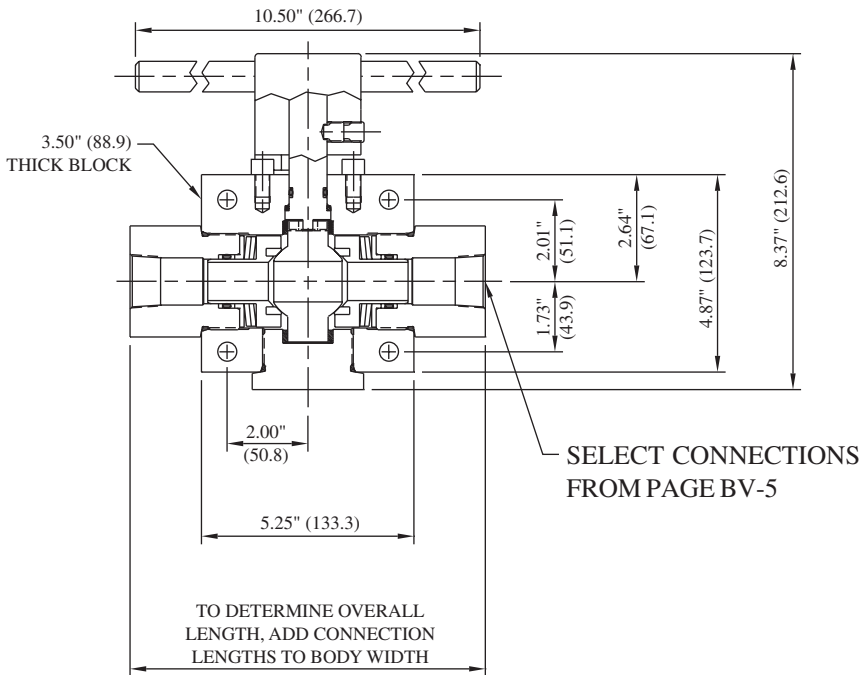

For replacement connections, use prefix number **160-** and suffix number. Ex: 160-20

Model No. K316

*MAWP: 3,000 PSI (210 bar)
 Port: 1.000" (25.4 mm)
 Cv: 36.00

Materials of Construction:

- 316 cold-worked stainless steel body and side adapters
- 17-4PH stem
- PEEK ball seals
- Viton O-rings
- PTFE back-ups

Ordering information and options on page BV-2

Repair Kit P/N RK-K316 contains stem, ball, ball seals and seal retainers, o-rings, spring washers, and bearing washers

FEMALE PIPE

Connection	Suffix	Hex	Length	Port	MAWP*
3/4" FNPT	41	2.75" (69.9)	1.05" (26.7)	0.922" (23.4)	10,000 PSI 690 bar
1" FNPT	45	2.75" (69.9)	1.22" (31.0)	1.102" (28.0)	10,000 PSI 690 bar
1-1/2" FNPT	46	2.75" (69.9)	1.63" (41.4)	1.102" (28.0)	5,000 PSI 340 bar

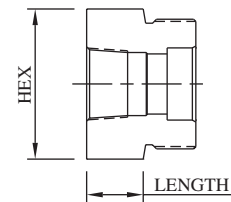

MALE PIPE

Connection	Suffix	Hex	Length	Port	MAWP*
3/4" MNPT	55	2.75" (69.9)	1.82" (46.2)	0.625" (15.9)	10,000 PSI 690 bar
1" MNPT	56	2.75" (69.9)	2.03" (51.6)	0.687" (17.4)	10,000 PSI 690 bar
1-1/2" MNPT	121	2.75" (69.9)	1.96" (49.8)	1.102" (28.0)	5,000 PSI 340 bar

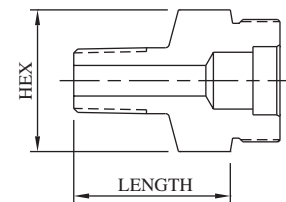

***CAUTION:** The maximum allowable working pressure (MAWP) of the valve shall not exceed the MAWP of the valve series or the selected connection, whichever is less.

All dimensions are for reference only and are subject to change.
 Dimensions in parentheses are millimeters (mm).



6000 PSI (410 BAR) 2-WAY BALL VALVES

Model No. K63

Mounting:

Panel: 0.91" (23.0 mm) dia
0.31" (7.8 mm) max thickness

*MAWP: 6,000 PSI (410 bar)
Port: 0.187" (4.7 mm)
Cv: 0.75

Materials of Construction:

- 316 cold-worked stainless steel body and side adapters
- 316 cold-worked stem
- PEEK ball seals
- Glass-filled PTFE stem packings
- Viton O-rings

Ordering information and options on page BV-2

Repair Kit P/N RK-K63 contains ball, ball seals and seal retainers, o-rings, spring washers, stem, stem packings, and washers

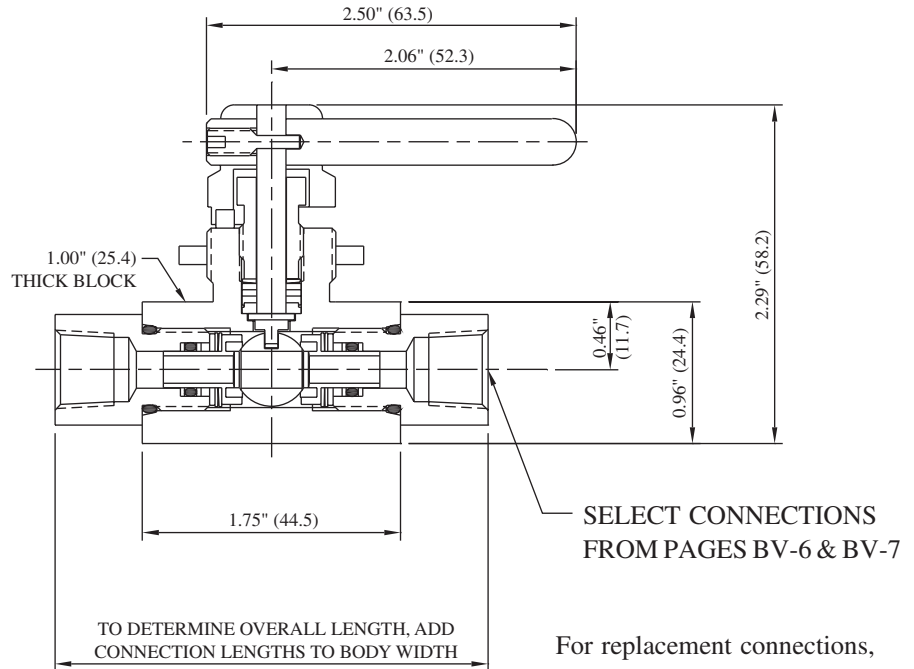

SELECT CONNECTIONS FROM PAGES BV-6 & BV-7

For replacement connections, use prefix number **3-** and suffix number. Ex: 3-20

FEMALE PIPE

Connection	Suffix	Hex	Length	Port	MAWP*
1/8" FNPT	19	0.75" (19.1)	0.60" (15.2)	0.250" (6.4)	15,000 PSI 1030 bar
1/4" FNPT	20	0.75" (19.1)	0.60" (15.2)	0.250" (6.4)	15,000 PSI 1030 bar
3/8" FNPT	21	1.00" (25.4)	1.01" (25.7)	0.250" (6.4)	15,000 PSI 1030 bar
1/2" FNPT	22	1.00" (25.4)	1.01" (25.7)	0.250" (6.4)	15,000 PSI 1030 bar

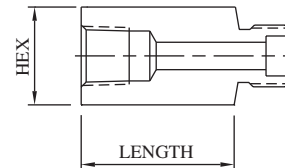

MALE PIPE

Connection	Suffix	Hex	Length	Port	MAWP*
1/8" MNPT	4	0.75" (19.1)	1.01" (25.7)	0.125" (3.2)	15,000 PSI 1030 bar
1/4" MNPT	5	0.75" (19.1)	1.01" (25.7)	0.250" (6.4)	15,000 PSI 1030 bar
3/8" MNPT	6	0.75" (19.1)	1.01" (25.7)	0.250" (6.4)	15,000 PSI 1030 bar
1/2" MNPT	7	1.00" (25.4)	1.26" (32.0)	0.250" (6.4)	15,000 PSI 1030 bar

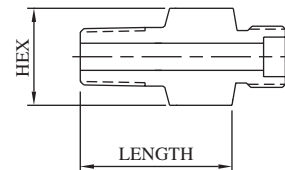

***CAUTION:** The maximum allowable working pressure (MAWP) of the valve shall not exceed the MAWP of the valve series or the selected connection, whichever is less.

All dimensions are for reference only and are subject to change.
Dimensions in parentheses are millimeters (mm).



6000 PSI (410 BAR) 2-WAY BALL VALVES

Model No. K63

FEMALE SINGLE-FERRULE TUBE

Connection	Suffix	Hex	Length	Port	MAWP*
1/8" L/P	12	0.75" (19.1)	0.78" (19.8)	0.093" (2.4)	15,000 PSI 1030 bar
1/4" SL/P	13	0.75" (19.1)	1.03" (26.2)	0.125" (3.2)	11,500 PSI 790 bar
3/8" SL/P	14	0.75" (19.1)	1.03" (26.2)	0.250" (6.4)	7,500 PSI 520 bar
1/2" L/P	15	1.00" (25.4)	1.03" (26.2)	0.250" (6.4)	5,500 PSI 380 bar

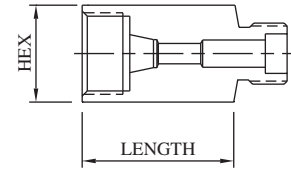

FEMALE M/P CONED AND THREADED TUBE

Connection	Suffix	Hex	Length	Port	MAWP*
1/4" M/P	16	0.75" (19.1)	0.74" (18.8)	0.109" (2.8)	20,000 PSI 1380 bar
3/8" M/P	17	0.75" (19.1)	1.01" (25.7)	0.203" (5.2)	20,000 PSI 1380 bar
9/16" M/P	18	1.00" (25.4)	1.26" (32.0)	0.250" (6.4)	20,000 PSI 1380 bar

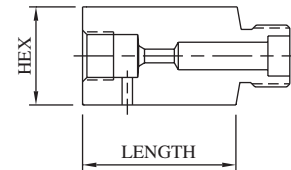

MALE M/P CONED AND THREADED TUBE

Connection	Suffix	Hex	Length	Port	MAWP*
1/4" M/P	8	0.75" (19.1)	1.88" (47.8)	0.109" (2.8)	20,000 PSI 1380 bar
3/8" M/P	10	0.75" (19.1)	2.00" (50.8)	0.203" (5.2)	20,000 PSI 1380 bar
9/16" M/P	11	1.00" (25.4)	2.31" (58.7)	0.250" (6.4)	20,000 PSI 1380 bar

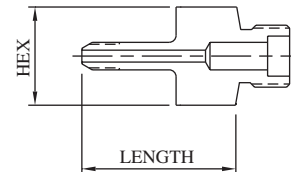

FEMALE H/P CONED AND THREADED TUBE

Connection	Suffix	Hex	Length	Port	MAWP*
1/4" H/P	23	0.75" (19.1)	1.01" (25.7)	0.093" (2.4)	20,000 PSI 1380 bar
3/8" H/P	24	1.00" (25.4)	1.17" (29.7)	0.125" (3.2)	20,000 PSI 1380 bar
9/16" H/P	25	1.37" (34.8)	1.25" (31.8)	0.187" (4.7)	20,000 PSI 1380 bar

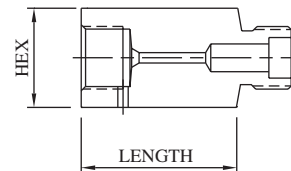

MALE H/P CONED AND THREADED TUBE

Connection	Suffix	Hex	Length	Port	MAWP*
1/4" H/P	9	0.75" (19.1)	1.94" (49.3)	0.083" (2.1)	20,000 PSI 1380 bar
3/8" H/P	30	0.75" (19.1)	2.25" (57.2)	0.125" (3.2)	20,000 PSI 1380 bar
9/16" H/P	42	0.75" (19.1)	2.82" (71.6)	0.187" (4.7)	20,000 PSI 1380 bar

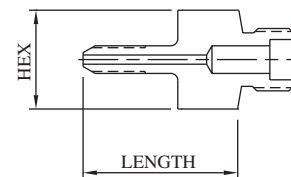

***CAUTION:** The maximum allowable working pressure (MAWP) of the valve shall not exceed the MAWP of the valve series or the selected connection, whichever is less.

All dimensions are for reference only and are subject to change.
Dimensions in parentheses are millimeters (mm).



10,000 PSI (690 BAR) 2-WAY BALL VALVES

Model No. K103

Mounting:

Panel: 0.91" (23.0 mm) dia
0.31" (7.8 mm) max thickness

*MAWP: 10,000 PSI (690 bar)
Port: 0.187" (4.7 mm)
Cv: 0.75

Materials of Construction:

- 316 cold-worked stainless steel body and side adapters
- 316 cold-worked stem
- PEEK ball seals
- Glass-filled PTFE stem packings
- Viton O-rings

Ordering information and options on page BV-2

Repair Kit P/N RK-K103 contains ball, ball seals and seal retainers, o-rings, spring washers, stem, stem packings, and washers

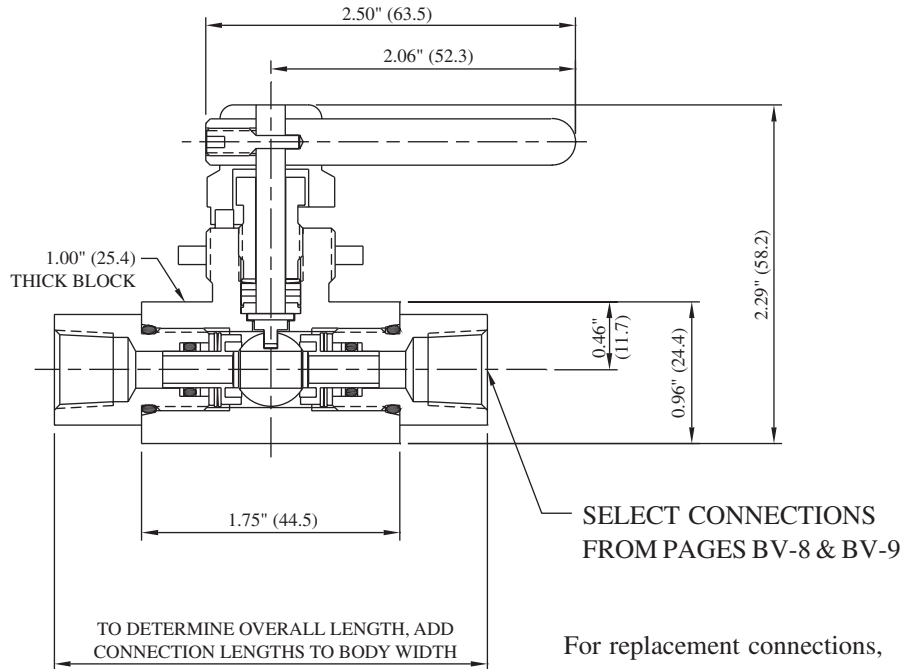

For replacement connections, use prefix number **3-** and suffix number. Ex: 3-20

FEMALE PIPE

Connection	Suffix	Hex	Length	Port	MAWP*
1/8" FNPT	19	0.75" (19.1)	0.60" (15.2)	0.250" (6.4)	15,000 PSI 1030 bar
1/4" FNPT	20	0.75" (19.1)	0.60" (15.2)	0.250" (6.4)	15,000 PSI 1030 bar
3/8" FNPT	21	1.00" (25.4)	1.01" (25.7)	0.250" (6.4)	15,000 PSI 1030 bar
1/2" FNPT	22	1.00" (25.4)	1.01" (25.7)	0.250" (6.4)	15,000 PSI 1030 bar

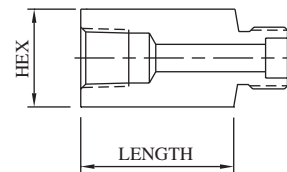

MALE PIPE

Connection	Suffix	Hex	Length	Port	MAWP*
1/8" MNPT	4	0.75" (19.1)	1.01" (25.7)	0.125" (3.2)	15,000 PSI 1030 bar
1/4" MNPT	5	0.75" (19.1)	1.01" (25.7)	0.250" (6.4)	15,000 PSI 1030 bar
3/8" MNPT	6	0.75" (19.1)	1.01" (25.7)	0.250" (6.4)	15,000 PSI 1030 bar
1/2" MNPT	7	1.00" (25.4)	1.26" (32.0)	0.250" (6.4)	15,000 PSI 1030 bar

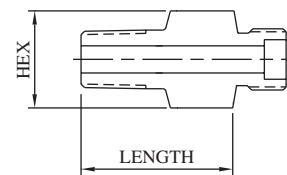

***CAUTION:** The maximum allowable working pressure (MAWP) of the valve shall not exceed the MAWP of the valve series or the selected connection, whichever is less.

All dimensions are for reference only and are subject to change.
Dimensions in parentheses are millimeters (mm).



10,000 PSI (690 BAR) 2-WAY BALL VALVES

Model No. K103

FEMALE SINGLE-FERRULE TUBE

Connection	Suffix	Hex	Length	Port	MAWP*
1/8" L/P	12	0.75" (19.1)	0.78" (19.8)	0.093" (2.4)	15,000 PSI 1030 bar
1/4" SL/P	13	0.75" (19.1)	1.03" (26.2)	0.125" (3.2)	11,500 PSI 790 bar
3/8" SL/P	14	0.75" (19.1)	1.03" (26.2)	0.250" (6.4)	7,500 PSI 520 bar
1/2" L/P	15	1.00" (25.4)	1.03" (26.2)	0.250" (6.4)	5,500 PSI 380 bar

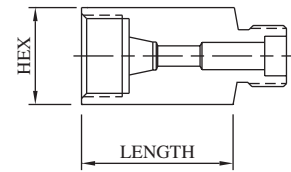

FEMALE M/P CONED AND THREADED TUBE

Connection	Suffix	Hex	Length	Port	MAWP*
1/4" M/P	16	0.75" (19.1)	0.74" (18.8)	0.109" (2.8)	20,000 PSI 1380 bar
3/8" M/P	17	0.75" (19.1)	1.01" (25.7)	0.203" (5.2)	20,000 PSI 1380 bar
9/16" M/P	18	1.00" (25.4)	1.26" (32.0)	0.250" (6.4)	20,000 PSI 1380 bar

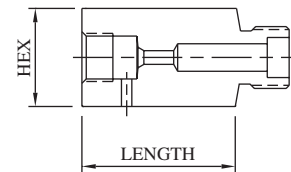

MALE M/P CONED AND THREADED TUBE

Connection	Suffix	Hex	Length	Port	MAWP*
1/4" M/P	8	0.75" (19.1)	1.88" (47.8)	0.109" (2.8)	20,000 PSI 1380 bar
3/8" M/P	10	0.75" (19.1)	2.00" (50.8)	0.203" (5.2)	20,000 PSI 1380 bar
9/16" M/P	11	1.00" (25.4)	2.31" (58.7)	0.250" (6.4)	20,000 PSI 1380 bar

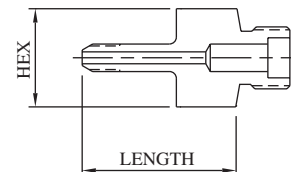

FEMALE H/P CONED AND THREADED TUBE

Connection	Suffix	Hex	Length	Port	MAWP*
1/4" H/P	23	0.75" (19.1)	1.01" (25.7)	0.093" (2.4)	20,000 PSI 1380 bar
3/8" H/P	24	1.00" (25.4)	1.17" (29.7)	0.125" (3.2)	20,000 PSI 1380 bar
9/16" H/P	25	1.37" (34.8)	1.25" (31.8)	0.187" (4.7)	20,000 PSI 1380 bar

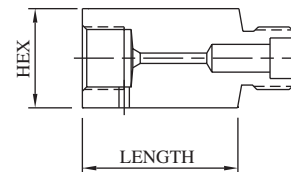

MALE H/P CONED AND THREADED TUBE

Connection	Suffix	Hex	Length	Port	MAWP*
1/4" H/P	9	0.75" (19.1)	1.94" (49.3)	0.083" (2.1)	20,000 PSI 1380 bar
3/8" H/P	30	0.75" (19.1)	2.25" (57.2)	0.125" (3.2)	20,000 PSI 1380 bar
9/16" H/P	42	0.75" (19.1)	2.82" (71.6)	0.187" (4.7)	20,000 PSI 1380 bar

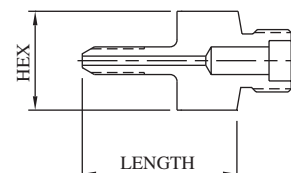

***CAUTION:** The maximum allowable working pressure (MAWP) of the valve shall not exceed the MAWP of the valve series or the selected connection, whichever is less.

All dimensions are for reference only and are subject to change.
Dimensions in parentheses are millimeters (mm).



10,000 PSI (690 BAR) 2-WAY BALL VALVES

Model No. K104

*MAWP: 10,000 PSI (690 bar)
 Port: 0.250" (6.4 mm)
 Cv: 1.40

Materials of Construction:

- 316 cold-worked stainless steel body and side adapters
- 17-4PH stem
- PEEK ball seals
- Glass-filled PTFE stem packings
- Viton O-rings

Ordering information and options on page BV-2

Repair Kit P/N RK-K104 contains ball, ball seals and seal retainers, o-rings, stem, stem packings, and washers

Mounting:

Panel: 1.06" (26.9 mm) dia
 0.43" (11.0 mm) max thickness
 Top: 1/4"-20 UNC
 Side: 0.28" (7.1 mm) dia

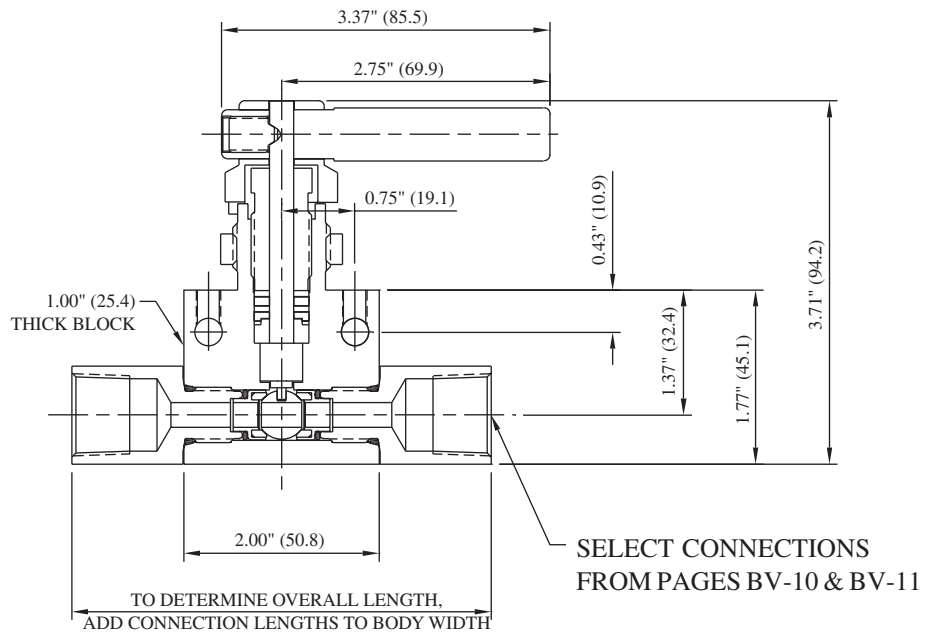

For replacement connections, use prefix number **4-** and suffix number. Ex: 4-20

FEMALE PIPE

Connection	Suffix	Hex	Length	Port	MAWP*
1/8" FNPT	19	0.75" (19.1)	1.03" (26.2)	0.250" (6.4)	15,000 PSI 1030 bar
1/4" FNPT	20	0.75" (19.1)	1.03" (26.2)	0.250" (6.4)	15,000 PSI 1030 bar
3/8" FNPT	21	1.38" (35.1)	1.03" (26.2)	0.250" (6.4)	15,000 PSI 1030 bar
1/2" FNPT	22	1.38" (35.1)	1.16" (29.5)	0.250" (6.4)	15,000 PSI 1030 bar

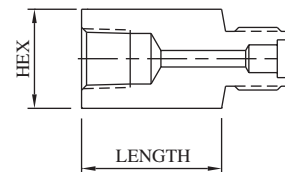

MALE PIPE

Connection	Suffix	Hex	Length	Port	MAWP*
1/8" MNPT	4	0.75" (19.1)	1.03" (26.2)	0.125" (3.2)	15,000 PSI 1030 bar
1/4" MNPT	5	0.75" (19.1)	1.03" (26.2)	0.250" (6.4)	15,000 PSI 1030 bar
3/8" MNPT	6	0.75" (19.1)	1.03" (26.2)	0.250" (6.4)	15,000 PSI 1030 bar
1/2" MNPT	7	1.00" (25.4)	1.29" (32.8)	0.250" (6.4)	15,000 PSI 1030 bar

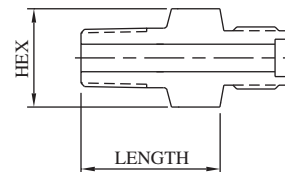

***CAUTION:** The maximum allowable working pressure (MAWP) of the valve shall not exceed the MAWP of the valve series or the selected connection, whichever is less.

All dimensions are for reference only and are subject to change.
 Dimensions in parentheses are millimeters (mm).



10,000 PSI (690 BAR) 2-WAY BALL VALVES

Model No. **K104**

FEMALE SINGLE-FERRULE TUBE

Connection	Suffix	Hex	Length	Port	MAWP*
1/8" L/P	12	0.75" (19.1)	0.78" (19.8)	0.093" (2.4)	15,000 PSI 1030 bar
1/4" SL/P	13	0.75" (19.1)	1.03" (26.2)	0.125" (3.2)	11,500 PSI 790 bar
3/8" SL/P	14	0.75" (19.1)	1.03" (26.2)	0.250" (6.4)	7,500 PSI 520 bar
1/2" L/P	15	1.00" (25.4)	1.03" (26.2)	0.250" (6.4)	5,500 PSI 380 bar

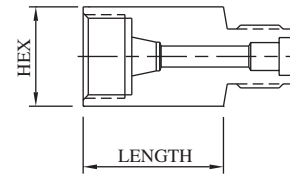

FEMALE M/P CONED AND THREADED TUBE

Connection	Suffix	Hex	Length	Port	MAWP*
1/4" M/P	16	0.75" (19.1)	1.03" (26.2)	0.109" (2.8)	20,000 PSI 1380 bar
3/8" M/P	17	0.75" (19.1)	1.03" (26.2)	0.203" (5.2)	20,000 PSI 1380 bar
9/16" M/P	18	1.00" (25.4)	1.29" (32.8)	0.250" (6.4)	20,000 PSI 1380 bar

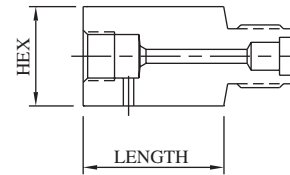

MALE M/P CONED AND THREADED TUBE

Connection	Suffix	Hex	Length	Port	MAWP*
1/4" M/P	8	0.75" (19.1)	1.91" (48.5)	0.109" (2.8)	20,000 PSI 1380 bar
3/8" M/P	10	0.75" (19.1)	1.91" (48.5)	0.203" (5.2)	20,000 PSI 1380 bar
9/16" M/P	11	0.75" (19.1)	2.12" (53.8)	0.312" (7.9)	20,000 PSI 1380 bar

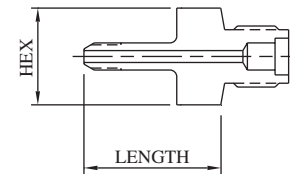

FEMALE H/P CONED AND THREADED TUBE

Connection	Suffix	Hex	Length	Port	MAWP*
1/4" H/P	23	0.75" (19.1)	1.03" (26.2)	0.093" (2.4)	20,000 PSI 1380 bar
3/8" H/P	24	1.00" (25.4)	1.03" (26.2)	0.125" (3.2)	20,000 PSI 1380 bar
9/16" H/P	25	1.38" (34.9)	1.16" (29.5)	0.187" (4.7)	20,000 PSI 1380 bar

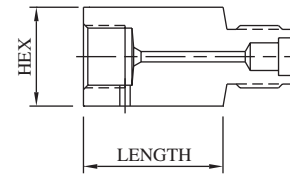

MALE H/P CONED AND THREADED TUBE

Connection	Suffix	Hex	Length	Port	MAWP*
1/4" H/P	9	0.75" (19.1)	1.91" (48.5)	0.093" (2.4)	20,000 PSI 1380 bar
3/8" H/P	30	0.75" (19.1)	2.12" (53.8)	0.125" (3.2)	20,000 PSI 1380 bar
9/16" H/P	42	0.75" (19.1)	2.86" (72.6)	0.187" (4.7)	20,000 PSI 1380 bar

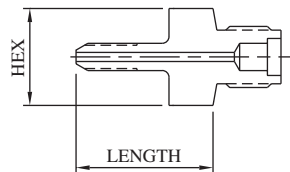

***CAUTION:** The maximum allowable working pressure (MAWP) of the valve shall not exceed the MAWP of the valve series or the selected connection, whichever is less.



All dimensions are for reference only and are subject to change.
Dimensions in parentheses are millimeters (mm).

10,000 PSI (690 BAR) 2-WAY BALL VALVES

Model No. K106

*MAWP: 10,000 PSI (690 bar)
 Port: 0.375" (9.5 mm)
 Cv: 3.40

Materials of Construction:

- 316 cold-worked stainless steel body and side adapters
- 17-4PH stem
- PEEK ball seals
- Glass-filled PTFE stem packings
- Viton O-rings

Ordering information and options on page BV-2

Repair Kit P/N RK-K106 contains ball, ball seals and seal retainers, o-rings, stem, stem packings, and washers

Mounting:

Panel: 1.06" (26.9 mm) dia
 0.43" (11.0 mm) max thickness
 Top: 1/4"-20 UNC
 Side: 0.28" (7.1 mm) dia

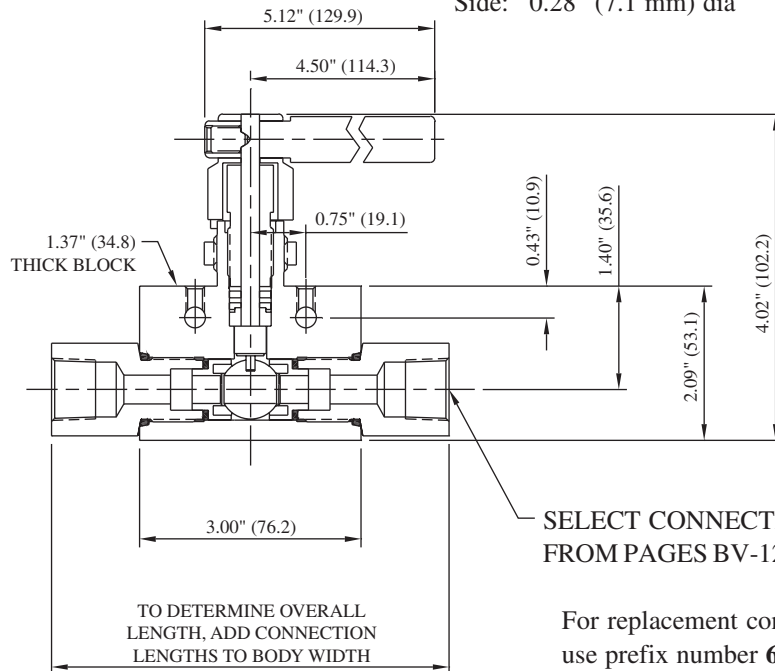

SELECT CONNECTIONS FROM PAGES BV-12 & BV-13

For replacement connections, use prefix number **6-** and suffix number. Ex: 6-20

FEMALE PIPE

Connection	Suffix	Hex	Length	Port	MAWP*
1/8" FNPT	19	1.00" (25.4)	0.69" (17.4)	0.339" (8.6)	15,000 PSI 1030 bar
1/4" FNPT	20	1.38" (34.9)	1.08" (27.4)	0.375" (9.5)	15,000 PSI 1030 bar
3/8" FNPT	21	1.38" (34.9)	1.02" (25.9)	0.375" (9.5)	15,000 PSI 1030 bar
1/2" FNPT	22	1.38" (34.9)	1.21" (30.7)	0.375" (9.5)	15,000 PSI 1030 bar
3/4" FNPT	41	1.38" (34.9)	1.33" (33.8)	0.375" (9.5)	10,000 PSI 690 bar
1" FNPT	45	1.75" (44.5)	1.62" (41.1)	0.375" (9.5)	10,000 PSI 690 bar

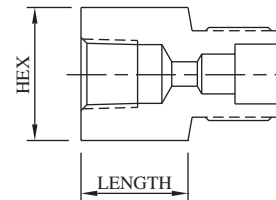

MALE PIPE

Connection	Suffix	Hex	Length	Port	MAWP*
1/8" MNPT	4	1.00" (25.4)	1.12" (28.4)	0.188" (4.8)	15,000 PSI 1030 bar
1/4" MNPT	5	1.38" (35.1)	1.41" (35.8)	0.258" (6.6)	15,000 PSI 1030 bar
3/8" MNPT	6	1.38" (34.9)	1.28" (32.5)	0.375" (9.5)	15,000 PSI 1030 bar
1/2" MNPT	7	1.38" (34.9)	1.33" (33.8)	0.375" (9.5)	15,000 PSI 1030 bar
3/4" MNPT	55	1.38" (35.1)	1.60" (40.6)	0.375" (9.5)	10,000 PSI 690 bar
1" MNPT	56	1.50" (38.1)	1.91" (48.5)	0.375" (9.5)	10,000 PSI 690 bar

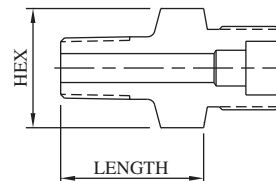

***CAUTION:** The maximum allowable working pressure (MAWP) of the valve shall not exceed the MAWP of the valve series or the selected connection, whichever is less.

All dimensions are for reference only and are subject to change.
 Dimensions in parentheses are millimeters (mm).



10,000 PSI (690 BAR) 2-WAY BALL VALVES

Model No. **K106**

FEMALE SINGLE-FERRULE TUBE

Connection	Suffix	Hex	Length	Port	MAWP*
1/4" SL/P	13	1.38" (34.9)	0.66" (16.8)	0.257" (6.5)	11,500 PSI 790 bar
3/8" SL/P	14	1.38" (34.9)	1.00" (25.4)	0.312" (7.9)	7,500 PSI 520 bar
1/2" L/P	15	1.38" (34.9)	1.08" (27.4)	0.375" (9.5)	5,500 PSI 380 bar

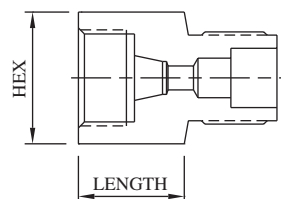

FEMALE M/P CONED AND THREADED TUBE

Connection	Suffix	Hex	Length	Port	MAWP
1/4" M/P	16	1.38" (35.1)	0.77" (19.6)	0.109" (2.8)	20,000 PSI 1380 bar
3/8" M/P	17	1.38" (35.1)	1.08" (27.4)	0.203" (5.2)	20,000 PSI 1380 bar
9/16" M/P	18	1.38" (35.1)	1.33" (33.8)	0.312" (7.9)	20,000 PSI 1380 bar
3/4" M/P	32	1.38" (35.1)	1.53" (38.9)	0.375" (9.5)	20,000 PSI 1380 bar
1" M/P	43	1.75" (44.5)	1.91" (48.5)	0.375" (9.5)	20,000 PSI 1380 bar

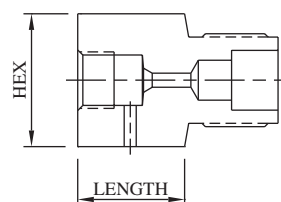

MALE M/P CONED AND THREADED TUBE

Connection	Suffix	Hex	Length	Port	MAWP*
1/4" M/P	8	1.00" (25.4)	1.89" (48.0)	0.109" (2.8)	20,000 PSI 1380 bar
3/8" M/P	10	1.38" (34.9)	1.90" (48.3)	0.203" (5.2)	20,000 PSI 1380 bar
9/16" M/P	11	1.38" (34.9)	2.13" (54.1)	0.312" (7.9)	20,000 PSI 1380 bar
3/4" M/P	37	1.38" (34.9)	5.08" (129.0)	0.437" (11.1)	20,000 PSI 1380 bar
1" M/P	49	1.38" (35.1)	3.21" (81.5)	0.437" (11.1)	20,000 PSI 1380 bar

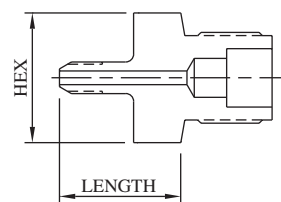

FEMALE H/P CONED AND THREADED TUBE

Connection	Suffix	Hex	Length	Port	MAWP*
1/4" H/P	23	1.38" (34.9)	1.02" (25.9)	0.083" (2.1)	20,000 PSI 1380 bar
3/8" H/P	24	1.38" (34.9)	1.04" (26.4)	0.125" (3.2)	20,000 PSI 1380 bar
9/16" H/P	25	1.38" (34.9)	1.13" (28.7)	0.187" (4.7)	20,000 PSI 1380 bar

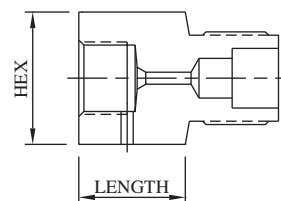

MALE H/P CONED AND THREADED TUBE

Connection	Suffix	Hex	Length	Port	MAWP*
1/4" H/P	9	1.00" (25.4)	1.98" (50.3)	0.083" (2.1)	20,000 PSI 1380 bar
3/8" H/P	30	1.00" (25.4)	2.38" (60.5)	0.125" (3.2)	20,000 PSI 1380 bar
9/16" H/P	42	1.00" (25.4)	2.85" (72.4)	0.188" (4.8)	20,000 PSI 1380 bar

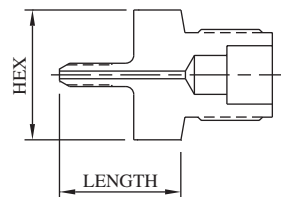

***CAUTION:** The maximum allowable working pressure (MAWP) of the valve shall not exceed the MAWP of the valve series or the selected connection, whichever is less.

All dimensions are for reference only and are subject to change.
Dimensions in parentheses are millimeters (mm).



10,000 PSI (690 BAR) 2-WAY BALL VALVES

Model No. K108

*MAWP: 10,000 PSI (690 bar)
 Port: 0.500" (12.7 mm)
 Cv: 10.00

Materials of Construction:

- 316 cold-worked stainless steel body and side adapters
- 17-4PH stem
- PEEK ball seals
- Glass-filled PTFE stem packings
- Viton O-rings

Ordering information and options on page BV-2

Repair Kit P/N RK-K108 contains ball, ball seals and seal retainers, o-rings, stem, stem packings, and washers

Mounting:

Side: 0.28" (7.1 mm) dia

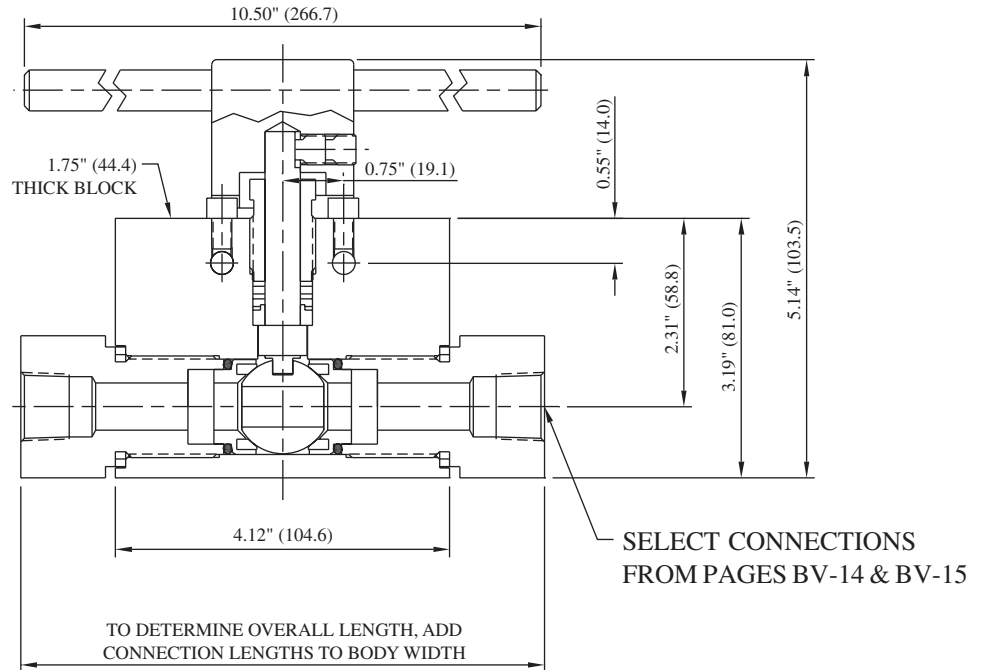

For replacement connections, use prefix number **8-** and suffix number. Ex: 8-22

FEMALE PIPE

Connection	Suffix	Hex	Length	Port	MAWP*
3/8" FNPT	21	1.75" (44.5)	1.00" (25.4)	0.578" (14.7)	15,000 PSI 1030 bar
1/2" FNPT	22	1.75" (44.5)	1.17" (29.7)	0.580" (14.7)	15,000 PSI 1030 bar
3/4" FNPT	41	1.75" (44.5)	1.33" (33.8)	0.580" (14.7)	10,000 PSI 690 bar
1" FNPT	45	1.75" (44.5)	1.54" (39.1)	0.580" (14.7)	10,000 PSI 690 bar
1-1/2" FNPT	46	2.50" (63.5)	1.92" (48.8)	0.580" (14.7)	5,000 PSI 340 bar

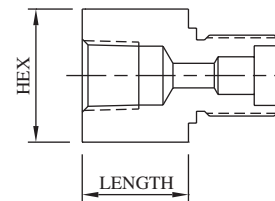

MALE PIPE

Connection	Suffix	Hex	Length	Port	MAWP*
3/8" MNPT	6	1.75" (44.5)	1.57" (39.9)	0.375" (9.5)	15,000 PSI 1030 bar
1/2" MNPT	7	1.75" (44.5)	1.80" (45.7)	0.500" (12.7)	15,000 PSI 1030 bar
3/4" MNPT	55	1.75" (44.5)	1.75" (44.5)	0.580" (14.7)	10,000 PSI 690 bar
1" MNPT	56	1.75" (44.5)	1.37" (34.8)	0.580" (14.7)	10,000 PSI 690 bar
1-1/2" MNPT	121	2.13" (54.0)	1.92" (48.8)	0.580" (14.7)	5,000 PSI 340 bar

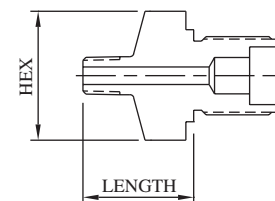

***CAUTION:** The maximum allowable working pressure (MAWP) of the valve shall not exceed the MAWP of the valve series or the selected connection, whichever is less.

All dimensions are for reference only and are subject to change.
 Dimensions in parentheses are millimeters (mm).



10,000 PSI (690 BAR) 2-WAY BALL VALVES

Model No. **K108**

FEMALE COMPRESSION TUBE CONNECTIONS

Connection	Suffix	Hex	Length	Port	MAWP*
3/8" SL/P	14	1.75" (44.5)	1.00" (25.4)	0.312" (7.9)	7,500 PSI 520 bar
1/2" L/P	15	1.75" (44.5)	1.00" (25.4)	0.438" (11.1)	5,500 PSI 380 bar

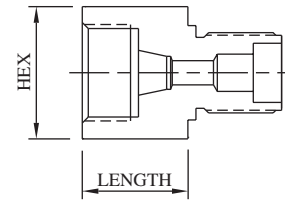

FEMALE M/P CONED AND THREADED TUBE

Connection	Suffix	Hex	Length	Port	MAWP*
3/8" M/P	17	1.75" (44.5)	0.87" (22.1)	0.203" (5.2)	20,000 PSI 1380 bar
9/16" M/P	18	1.75" (44.5)	1.67" (42.4)	0.312" (7.9)	20,000 PSI 1380 bar
3/4" M/P	32	1.75" (44.5)	1.18" (30.0)	0.580" (14.7)	20,000 PSI 1380 bar
1" M/P	43	1.75" (44.5)	1.67" (42.4)	0.580" (14.7)	20,000 PSI 1380 bar

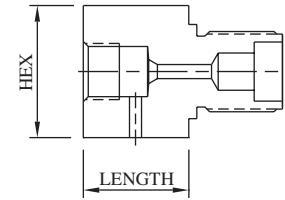

MALE M/P CONED AND THREADED TUBE

Connection	Suffix	Hex	Length	Port	MAWP*
3/8" M/P	10	1.75" (44.5)	2.33" (59.2)	0.203" (5.2)	20,000 PSI 1380 bar
9/16" M/P	11	1.75" (44.5)	2.71" (68.8)	0.312" (7.9)	20,000 PSI 1380 bar
3/4" M/P	37	1.75" (44.5)	2.74" (69.6)	0.438" (11.1)	20,000 PSI 1380 bar
1" M/P	49	1.75" (44.5)	2.88" (73.2)	0.562" (14.3)	20,000 PSI 1380 bar

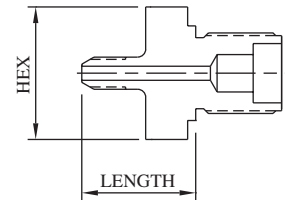

FEMALE H/P CONED AND THREADED TUBE

Connection	Suffix	Hex	Length	Port	MAWP*
1/4" H/P	23	1.75" (44.5)	0.63" (16.0)	0.093" (2.4)	20,000 PSI 1380 bar
3/8" H/P	24	1.75" (44.5)	1.00" (25.4)	0.125" (3.2)	20,000 PSI 1380 bar
9/16" H/P	25	1.75" (44.5)	1.06" (26.9)	0.188" (4.8)	20,000 PSI 1380 bar

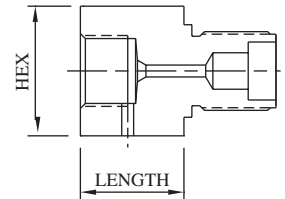

MALE H/P CONED AND THREADED TUBE

Connection	Suffix	Hex	Length	Port	MAWP*
1/4" H/P	9	1.75" (44.5)	2.22" (56.4)	0.083" (2.1)	20,000 PSI 1380 bar
3/8" H/P	30	1.75" (44.5)	2.45" (62.2)	0.125" (3.2)	20,000 PSI 1380 bar
9/16" H/P	42	1.75" (44.5)	2.96" (75.2)	0.188" (4.8)	20,000 PSI 1380 bar

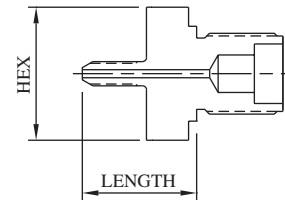

***CAUTION:** The maximum allowable working pressure (MAWP) of the valve shall not exceed the MAWP of the valve series or the selected connection, whichever is less.

All dimensions are for reference only and are subject to change.
Dimensions in parentheses are millimeters (mm).



20,000 PSI (1380 BAR) 2-WAY BALL VALVES

Model No. K204

*MAWP: 20,000 PSI (1380 bar)
 Port: 0.250" (6.4 mm)
 Cv: 1.40

Materials of Construction:

- 316 cold-worked stainless steel body and side adapters
- 17-4PH stem
- PEEK ball seals
- Glass-filled PTFE stem packings
- Viton O-rings

Ordering information and options on page BV-2

Repair Kit P/N RK-K204 contains ball, ball seals and seal retainers, o-rings, stem, stem packings, and washers

Mounting:

Panel: 1.06" (26.9 mm) dia
 0.43" (11.0 mm) max thickness
 Top: 1/4"-20 UNC
 Side: 0.28" (7.1 mm) dia

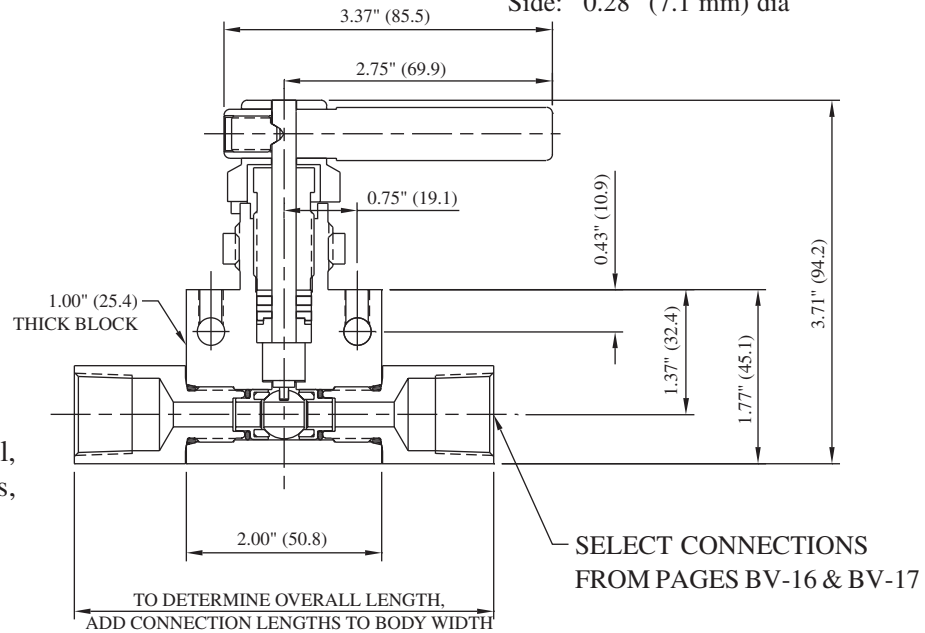

For replacement connections, use prefix number **4-** and suffix number. Ex: 4-20

FEMALE PIPE

Connection	Suffix	Hex	Length	Port	MAWP*
1/8" FNPT	19	0.75" (19.1)	1.03" (26.2)	0.250" (6.4)	15,000 PSI 1030 bar
1/4" FNPT	20	0.75" (19.1)	1.03" (26.2)	0.250" (6.4)	15,000 PSI 1030 bar
3/8" FNPT	21	1.38" (35.1)	1.03" (26.2)	0.250" (6.4)	15,000 PSI 1030 bar
1/2" FNPT	22	1.38" (35.1)	1.16" (29.5)	0.250" (6.4)	15,000 PSI 1030 bar

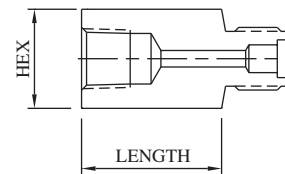

MALE PIPE

Connection	Suffix	Hex	Length	Port	MAWP*
1/8" MNPT	4	0.75" (19.1)	1.03" (26.2)	0.125" (3.2)	15,000 PSI 1030 bar
1/4" MNPT	5	0.75" (19.1)	1.03" (26.2)	0.250" (6.4)	15,000 PSI 1030 bar
3/8" MNPT	6	0.75" (19.1)	1.03" (26.2)	0.250" (6.4)	15,000 PSI 1030 bar
1/2" MNPT	7	1.00" (25.4)	1.29" (32.8)	0.250" (6.4)	15,000 PSI 1030 bar

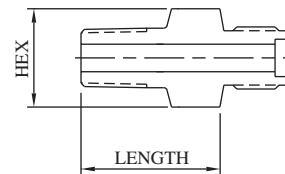

***CAUTION:** The maximum allowable working pressure (MAWP) of the valve shall not exceed the MAWP of the valve series or the selected connection, whichever is less.

All dimensions are for reference only and are subject to change.
 Dimensions in parentheses are millimeters (mm).



20,000 PSI (1380 BAR) 2-WAY BALL VALVES

Model No. K204

FEMALE SINGLE-FERRULE TUBE

Connection	Suffix	Hex	Length	Port	MAWP*
1/8" L/P	12	0.75" (19.1)	0.78" (19.8)	0.093" (2.4)	15,000 PSI 1030 bar
1/4" SL/P	13	0.75" (19.1)	1.03" (26.2)	0.125" (3.2)	11,500 PSI 790 bar
3/8" SL/P	14	0.75" (19.1)	1.03" (26.2)	0.250" (6.4)	7,500 PSI 520 bar
1/2" L/P	15	1.00" (25.4)	1.03" (26.2)	0.250" (6.4)	5,500 PSI 380 bar

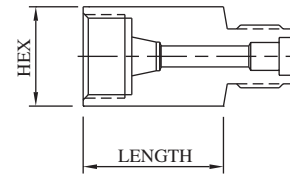

FEMALE M/P CONED AND THREADED TUBE

Connection	Suffix	Hex	Length	Port	MAWP*
1/4" M/P	16	0.75" (19.1)	1.03" (26.2)	0.109" (2.8)	20,000 PSI 1380 bar
3/8" M/P	17	0.75" (19.1)	1.03" (26.2)	0.203" (5.2)	20,000 PSI 1380 bar
9/16" M/P	18	1.00" (25.4)	1.29" (32.8)	0.250" (6.4)	20,000 PSI 1380 bar

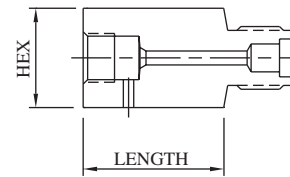

MALE M/P CONED AND THREADED TUBE

Connection	Suffix	Hex	Length	Port	MAWP*
1/4" M/P	8	0.75" (19.1)	1.91" (48.5)	0.109" (2.8)	20,000 PSI 1380 bar
3/8" M/P	10	0.75" (19.1)	1.91" (48.5)	0.203" (5.2)	20,000 PSI 1380 bar
9/16" M/P	11	0.75" (19.1)	2.12" (53.8)	0.312" (7.9)	20,000 PSI 1380 bar

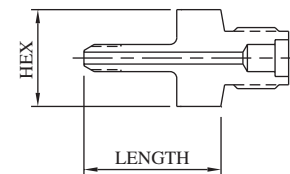

FEMALE H/P CONED AND THREADED TUBE

Connection	Suffix	Hex	Length	Port	MAWP*
1/4" H/P	23	0.75" (19.1)	1.03" (26.2)	0.093" (2.4)	20,000 PSI 1380 bar
3/8" H/P	24	1.00" (25.4)	1.03" (26.2)	0.125" (3.2)	20,000 PSI 1380 bar
9/16" H/P	25	1.38" (34.9)	1.16" (29.5)	0.187" (4.7)	20,000 PSI 1380 bar

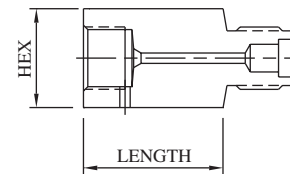

MALE H/P CONED AND THREADED TUBE

Connection	Suffix	Hex	Length	Port	MAWP*
1/4" H/P	9	0.75" (19.1)	1.91" (48.5)	0.093" (2.4)	20,000 PSI 1380 bar
3/8" H/P	30	0.75" (19.1)	2.12" (53.8)	0.125" (3.2)	20,000 PSI 1380 bar
9/16" H/P	42	0.75" (19.1)	2.86" (72.6)	0.187" (4.7)	20,000 PSI 1380 bar

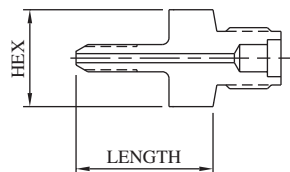

***CAUTION:** The maximum allowable working pressure (MAWP) of the valve shall not exceed the MAWP of the valve series or the selected connection, whichever is less.



All dimensions are for reference only and are subject to change.
Dimensions in parentheses are millimeters (mm).

20,000 PSI (1380 BAR) 2-WAY BALL VALVES

Model No. K206

*MAWP: 20,000 PSI (1380 bar)
 Port: 0.375" (9.5 mm)
 Cv: 3.40

Materials of Construction:

- 316 cold-worked stainless steel body and side adapters
- 17-4PH stem
- PEEK ball seals
- Glass-filled PTFE stem packings
- Viton O-rings

Ordering information and options on page BV-2

Repair Kit P/N RK-K206 contains ball, ball seals and seal retainers, o-rings, stem, stem packings, and washers

Mounting:

Panel: 1.06" (26.9 mm) dia
 0.43" (11.0 mm) max thickness
 Top: 1/4"-20 UNC
 Side: 0.28" (7.1 mm) dia

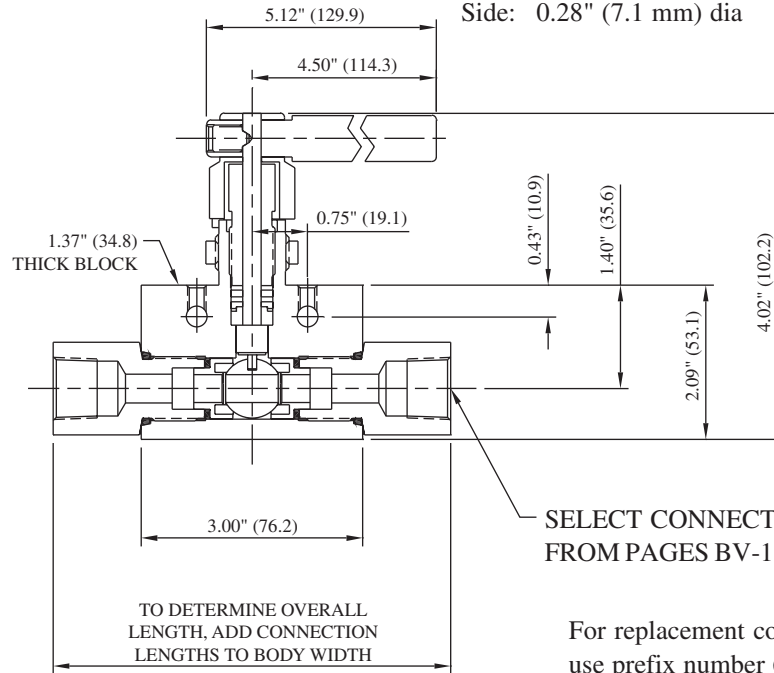

For replacement connections, use prefix number **6-** and suffix number. Ex: 6-20

FEMALE PIPE

Connection	Suffix	Hex	Length	Port	MAWP*
1/8" FNPT	19	1.00" (25.4)	0.69" (17.4)	0.339" (8.6)	15,000 PSI 1030 bar
1/4" FNPT	20	1.38" (34.9)	1.08" (27.4)	0.375" (9.5)	15,000 PSI 1030 bar
3/8" FNPT	21	1.38" (34.9)	1.02" (25.9)	0.375" (9.5)	15,000 PSI 1030 bar
1/2" FNPT	22	1.38" (34.9)	1.21" (30.7)	0.375" (9.5)	15,000 PSI 1030 bar
3/4" FNPT	41	1.38" (34.9)	1.33" (33.8)	0.375" (9.5)	10,000 PSI 690 bar
1" FNPT	45	1.75" (44.5)	1.62" (41.1)	0.375" (9.5)	10,000 PSI 690 bar

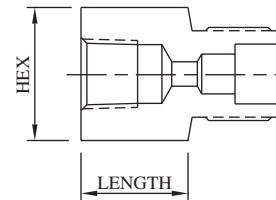

MALE PIPE

Connection	Suffix	Hex	Length	Port	MAWP*
1/8" MNPT	4	1.00" (25.4)	1.12" (28.4)	0.188" (4.8)	15,000 PSI 1030 bar
1/4" MNPT	5	1.38" (35.1)	1.41" (35.8)	0.258" (6.6)	15,000 PSI 1030 bar
3/8" MNPT	6	1.38" (34.9)	1.28" (32.5)	0.375" (9.5)	15,000 PSI 1030 bar
1/2" MNPT	7	1.38" (34.9)	1.33" (33.8)	0.375" (9.5)	15,000 PSI 1030 bar
3/4" MNPT	55	1.38" (35.1)	1.60" (40.6)	0.375" (9.5)	10,000 PSI 690 bar
1" MNPT	56	1.50" (38.1)	1.91" (48.5)	0.375" (9.5)	10,000 PSI 690 bar

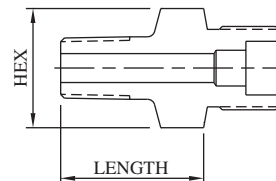

***CAUTION:** The maximum allowable working pressure (MAWP) of the valve shall not exceed the MAWP of the valve series or the selected connection, whichever is less.

All dimensions are for reference only and are subject to change.
 Dimensions in parentheses are millimeters (mm).



20,000 PSI (1380 BAR) 2-WAY BALL VALVES

Model No. **K206**

FEMALE SINGLE-FERRULE TUBE

Connection	Suffix	Hex	Length	Port	MAWP*
1/4" SL/P	13	1.38" (34.9)	0.66" (16.8)	0.257" (6.5)	11,500 PSI 790 bar
3/8" SL/P	14	1.38" (34.9)	1.00" (25.4)	0.312" (7.9)	7,500 PSI 520 bar
1/2" L/P	15	1.38" (34.9)	1.08" (27.4)	0.375" (9.5)	5,500 PSI 380 bar

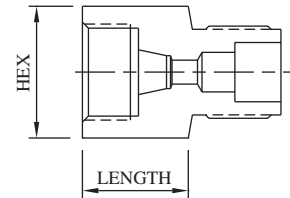

FEMALE M/P CONED AND THREADED TUBE

Connection	Suffix	Hex	Length	Port	MAWP
1/4" M/P	16	1.38" (35.1)	0.77" (19.6)	0.109" (2.8)	20,000 PSI 1380 bar
3/8" M/P	17	1.38" (35.1)	1.08" (27.4)	0.203" (5.2)	20,000 PSI 1380 bar
9/16" M/P	18	1.38" (35.1)	1.33" (33.8)	0.312" (7.9)	20,000 PSI 1380 bar
3/4" M/P	32	1.38" (35.1)	1.53" (38.9)	0.375" (9.5)	20,000 PSI 1380 bar
1" M/P	43	1.75" (44.5)	1.91" (48.5)	0.375" (9.5)	20,000 PSI 1380 bar

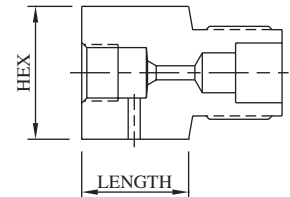

MALE M/P CONED AND THREADED TUBE

Connection	Suffix	Hex	Length	Port	MAWP*
1/4" M/P	8	1.00" (25.4)	1.89" (48.0)	0.109" (2.8)	20,000 PSI 1380 bar
3/8" M/P	10	1.38" (34.9)	1.90" (48.3)	0.203" (5.2)	20,000 PSI 1380 bar
9/16" M/P	11	1.38" (34.9)	2.13" (54.1)	0.312" (7.9)	20,000 PSI 1380 bar
3/4" M/P	37	1.38" (34.9)	5.08" (129.0)	0.437" (11.1)	20,000 PSI 1380 bar
1" M/P	49	1.38" (35.1)	3.21" (81.5)	0.437" (11.1)	20,000 PSI 1380 bar

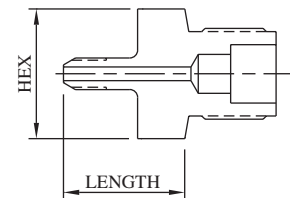

FEMALE H/P CONED AND THREADED TUBE

Connection	Suffix	Hex	Length	Port	MAWP*
1/4" H/P	23	1.38" (34.9)	1.02" (25.9)	0.083" (2.1)	20,000 PSI 1380 bar
3/8" H/P	24	1.38" (34.9)	1.04" (26.4)	0.125" (3.2)	20,000 PSI 1380 bar
9/16" H/P	25	1.38" (34.9)	1.13" (28.7)	0.187" (4.7)	20,000 PSI 1380 bar

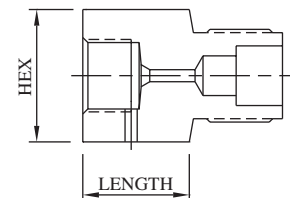

MALE H/P CONED AND THREADED TUBE

Connection	Suffix	Hex	Length	Port	MAWP*
1/4" H/P	9	1.00" (25.4)	1.98" (50.3)	0.083" (2.1)	20,000 PSI 1380 bar
3/8" H/P	30	1.00" (25.4)	2.38" (60.5)	0.125" (3.2)	20,000 PSI 1380 bar
9/16" H/P	42	1.00" (25.4)	2.85" (72.4)	0.188" (4.8)	20,000 PSI 1380 bar

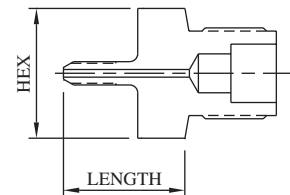

***CAUTION:** The maximum allowable working pressure (MAWP) of the valve shall not exceed the MAWP of the valve series or the selected connection, whichever is less.



All dimensions are for reference only and are subject to change.
Dimensions in parentheses are millimeters (mm).